



PGL-III-635/1~300mW

**PORTABLE RED LASER  
AT 635nm**



PGL-III-635 is made features of small size, driven by battery, special safety parts design.

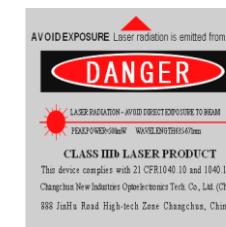

**SPECIFICATIONS**

Wavelength (nm)	635±5	
Operating mode	CW	
Output power (mW)	>1, 10,20, ..., 100	>100,200, ..., 300
Transverse mode	Near TEM <sub>00</sub>	TE <sub>00</sub>
Beam diameter at the aperture (1/e <sup>2</sup> , mm)	~3.5	~6.0
Beam divergence, full angle (mrad)	<1.0	<5.0
Operating temperature (°C)	0~40	
Switch	Push button	
Surface color	Black	
Power Consumption	DC 3V	
Power supply	2×“C”size 1.5V Alkaline batteries	
Expected lifetime (hours)	5000	
Warranty	6 months	
Remark	LED indicator, remote connector and key switch are available.	



PGL-III-635	Dimensions	Accessory
 <p>Φ38×234(L) mm<sup>2</sup>, 0.3 kg</p>		 <p>2×“C”size/1.5V batteries</p>